

FLUE GAS OUTLET CONNECTION		
FLANGE DIMENSIONS	in	mm
O.D.	15.00	381
I.D.	10.25	260
B.C.D	12.50	318
HOLE DIAMETER	0.53	13
No. OF HOLES	6	

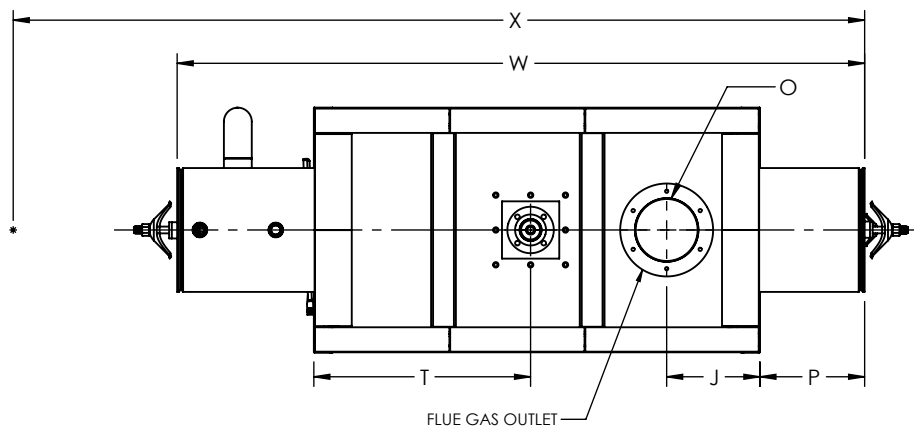

**TOP VIEW**

GENERAL DIMENSIONS		
	in	mm
A	BOILER BASE LENGTH	72.02 1829
B	BOILER HOUSING HEIGHT	83.66 2125
C	BOILER BASE WIDTH	39.50 1003
D	CENTER OF BOTTOM DRUM TO CENTER OF TOP DRUM	59.00 1499
E	CENTER OF BOTTOM DRUM TO BOTTOM	9.50 241
F	CENTER OF BURNER OPENING TO BOTTOM	27.85 707
G	STEAM OUTLET, FLANGE, CLASS 150 (NPS)	3.00 76
H	TOP DRUM CLEARANCE FROM FRONT	22.12 562
J	CENTER OF FLUE GAS OUTLET TO REAR	15.01 381
K	BOTTOM DRUM CLEARANCE FROM FRONT	17.13 435
L	TUBE REMOVAL CLEARANCE FROM BASE	23.00 584
M	UPPER DRUM, O.D.	20.00 508
N	LOWER DRUM, O.D.	8.63 219
O	FLUE GAS OUTLET, I.D.	10.00 254
P	TOP DRUM CLEARANCE FROM REAR	16.95 431
Q	BOTTOM BLOWDOWN (NPT)	1.50 38
R	BURNER LENGTH	0.00
S	CENTER OF TOP DRUM TO TOP OF STEAM OUTLET	16.50 419
T	CENTER OF STEAM OUTLET TO FRONT	34.95 888
U	FEEDWATER INLET, COUPLING (NPT)	1.25 32
V	FEEDWATER ELEVATION FROM BOTTOM	44.50 1130
W	OVERALL BOILER LENGTH	111.00 2819
X	OVERALL BOILER LENGTH WITH BURNER	0.00
Y	OVERALL BOILER HEIGHT	85.00 2159

NOTE: DIMENSIONS SUBJECT TO CHANGE WITHOUT NOTICE. CONSULT FACTORY FOR CERTIFIED DIMENSIONS.

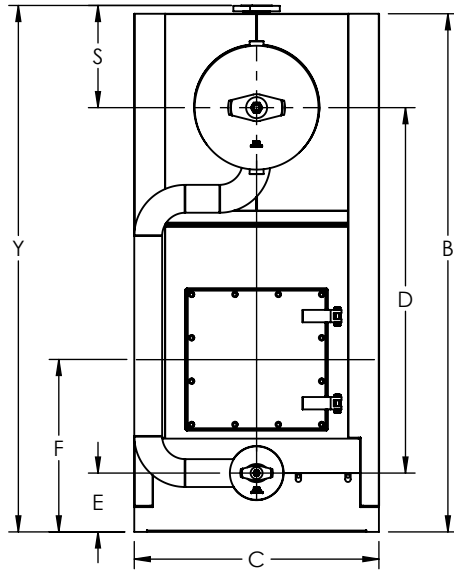

**FRONT VIEW**

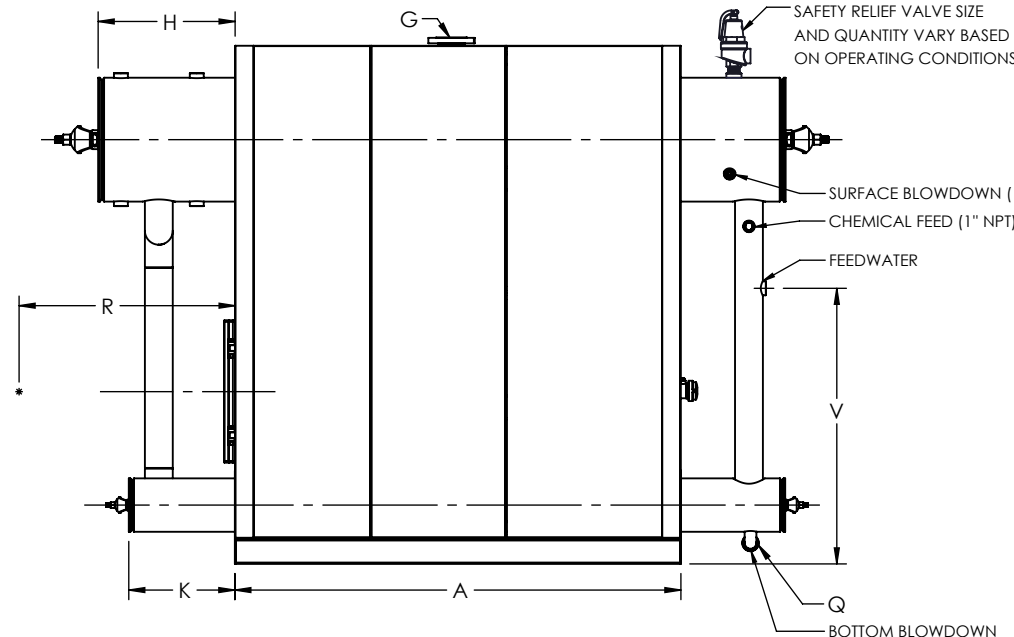

**SIDE VIEW**

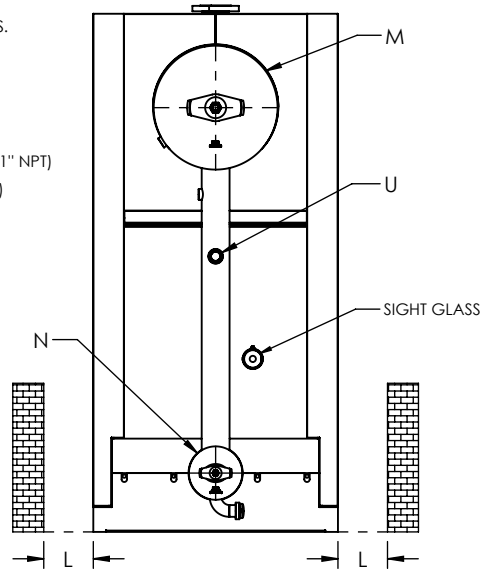

**REAR VIEW**

ZONE	REV.	DESCRIPTION	DATE
REVISIONS			

PROJECT:	-
LOCATION:	-
MODEL:	ZF 250LS
BURNER:	-
ELECTRIC:	-
SUPPLY PSI:	-

**UNILUX ADVANCED MFG., LLC.**  
 30 COMMERCE PARK DRIVE  
 NISKAYUNA, NY 12309  
 Ph: (518) 344-7490



THIS DRAWING EMBODIES A CONFIDENTIAL PROPRIETARY DESIGN. ALL RIGHTS FOR REPRODUCTION, MANUFACTURING OR PATENTS ARE RESERVED BY UNILUX ADVANCED MANUFACTURING, LLC.

Drawn By:	-	Date:	-
Checked By:	-	Date:	-
Drawing No.:	ZF 250LS-SUBMITTAL		
File No.:	QBXXX	REV.:	00